

WN 055451-45532
03/09

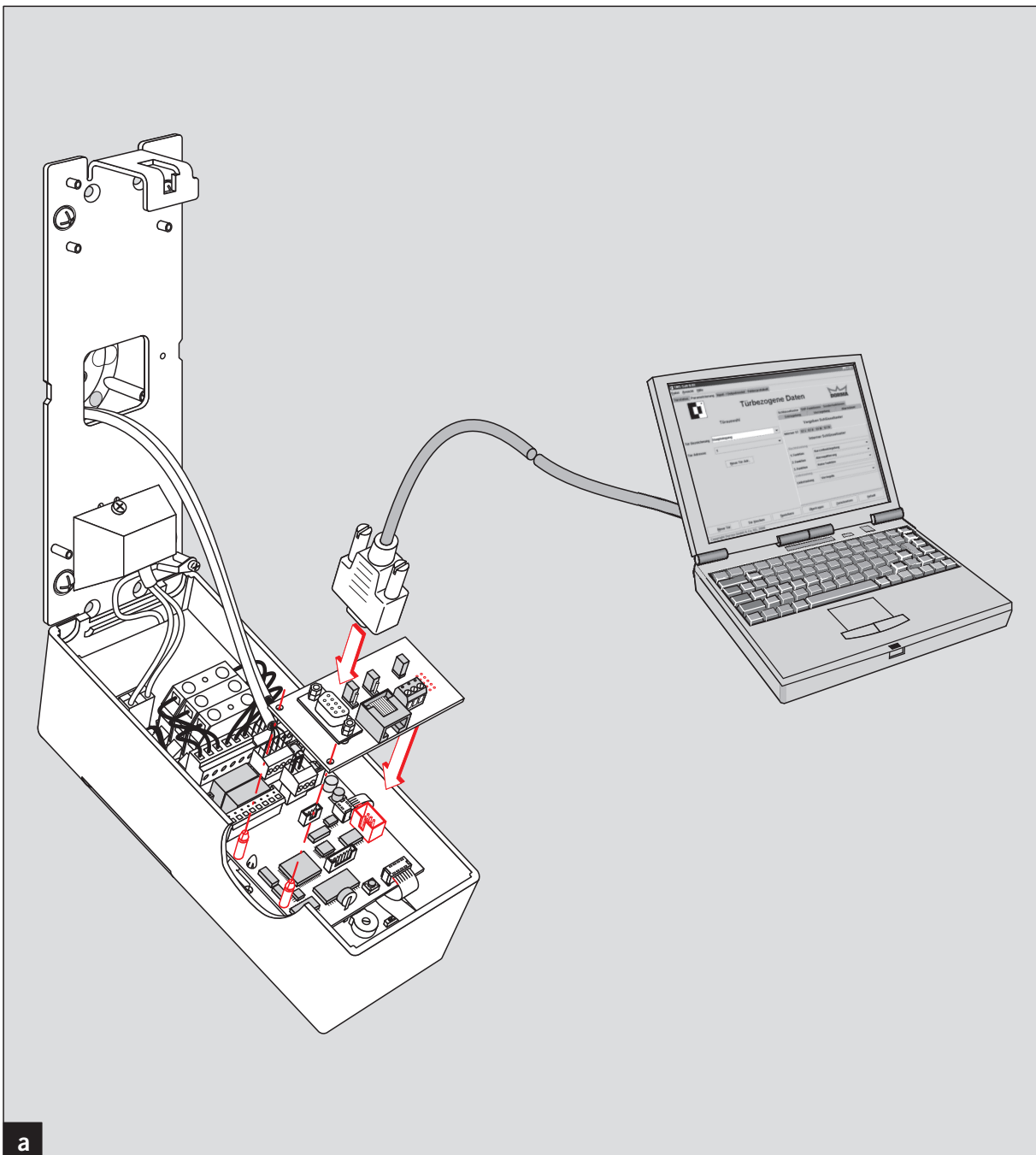

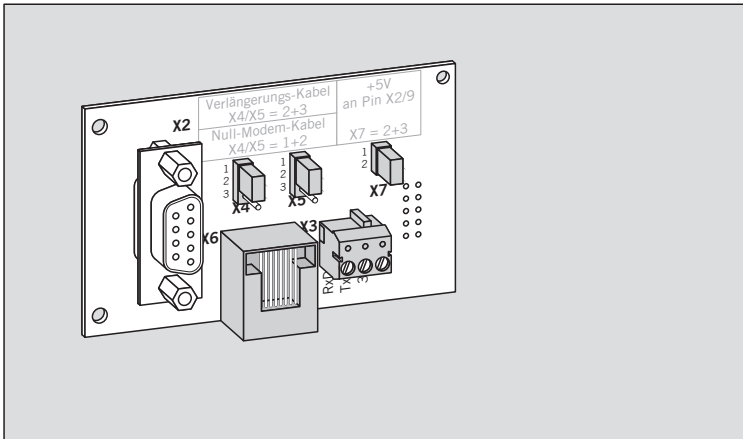
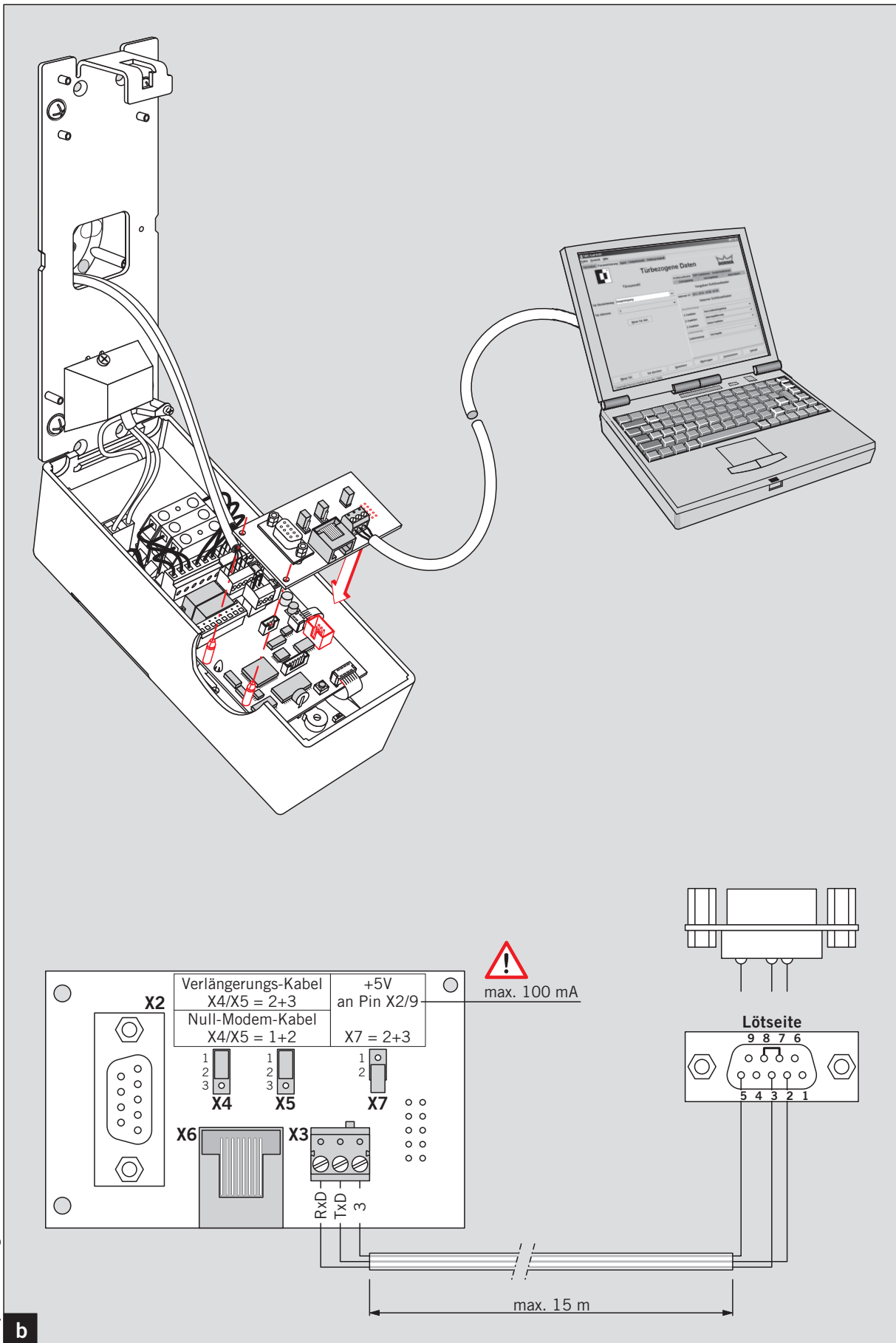

Änderungen vorbehalten
 Subject to change without notice